



# **HALKE SMART LOCK**

## **HA42**

**MANUAL**





## HALKE SMART LOCK HA42

### FEATRUES

- **Material:** Stainless Steel
- Lock size: **280 mm x 38 mm x 28 mm**
- Door Thickness: **30- 80 mm**
- Working voltage **6V (4\*AAA batteries)**
- The smart lock has 6 different ways to unlock- fingerprint reader, PIN-code, WiFi opening, mobile APP, smart card and mechanical key.
- Battery life: 10 000 times locking and unlocking operation
- **Color:** black, silver
- Working Temperature **-20°C~70°C**
- Lock weight 2.5 kg
- Halke smart lock has a user-friendly and constantly evolving mobile app that lets You control the lock via smartphone.
- The smart lock can be unlocked in case of a emergency with an auxiliary power supply or mechanically with a key.
- The lock is suitable for Airbnb, home, office, store, hotel etc. doors.

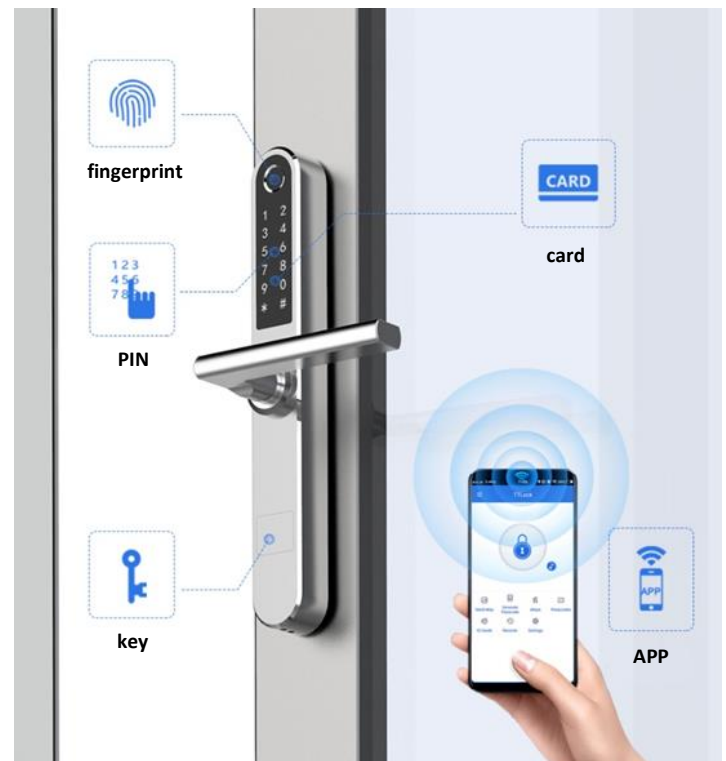

**LOCK FORCE OÜ**

Laki 30, Tallinn 12915

Ph: +372 660 9997, e-mail: [info@lockforce.ee](mailto:info@lockforce.ee)

[www.lockforce.ee](http://www.lockforce.ee)

# DRAWINGS

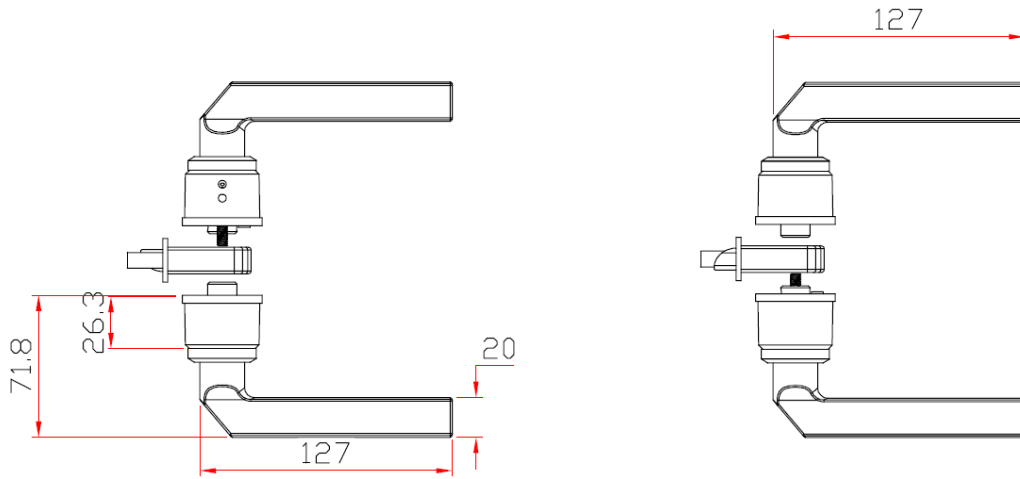
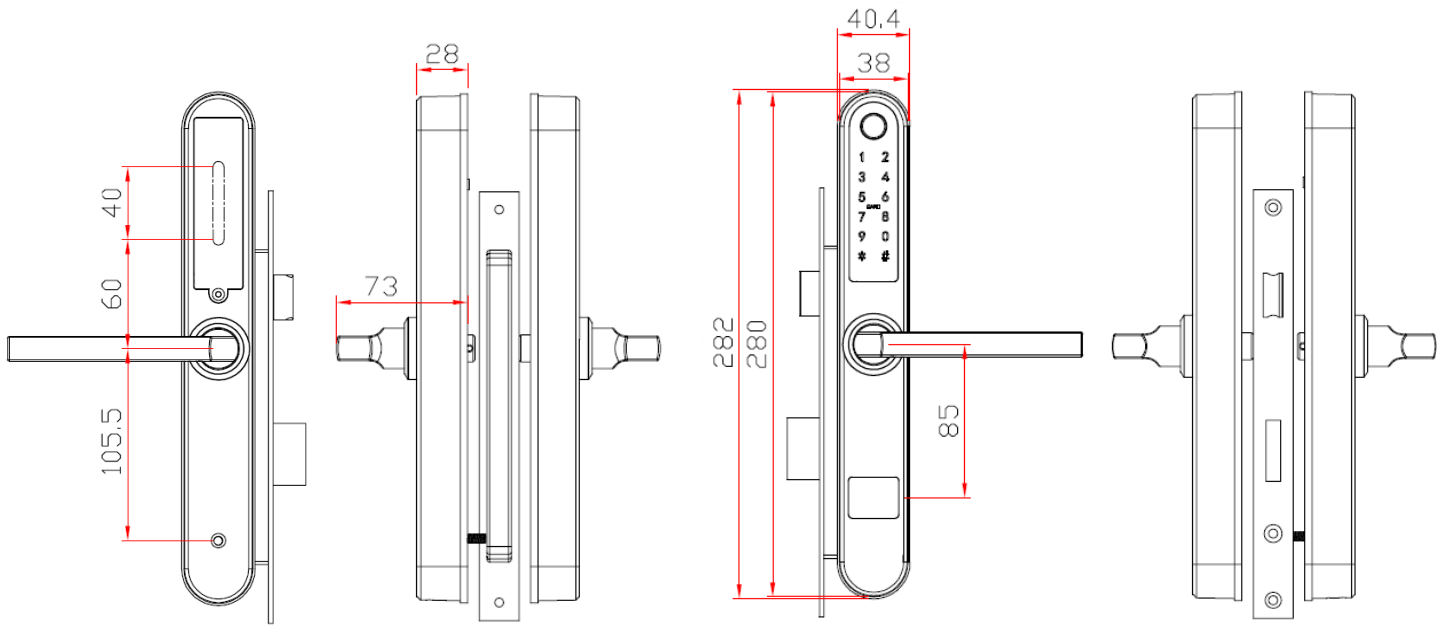

# LOCK CASES FOR ALUMINIUM DOORS

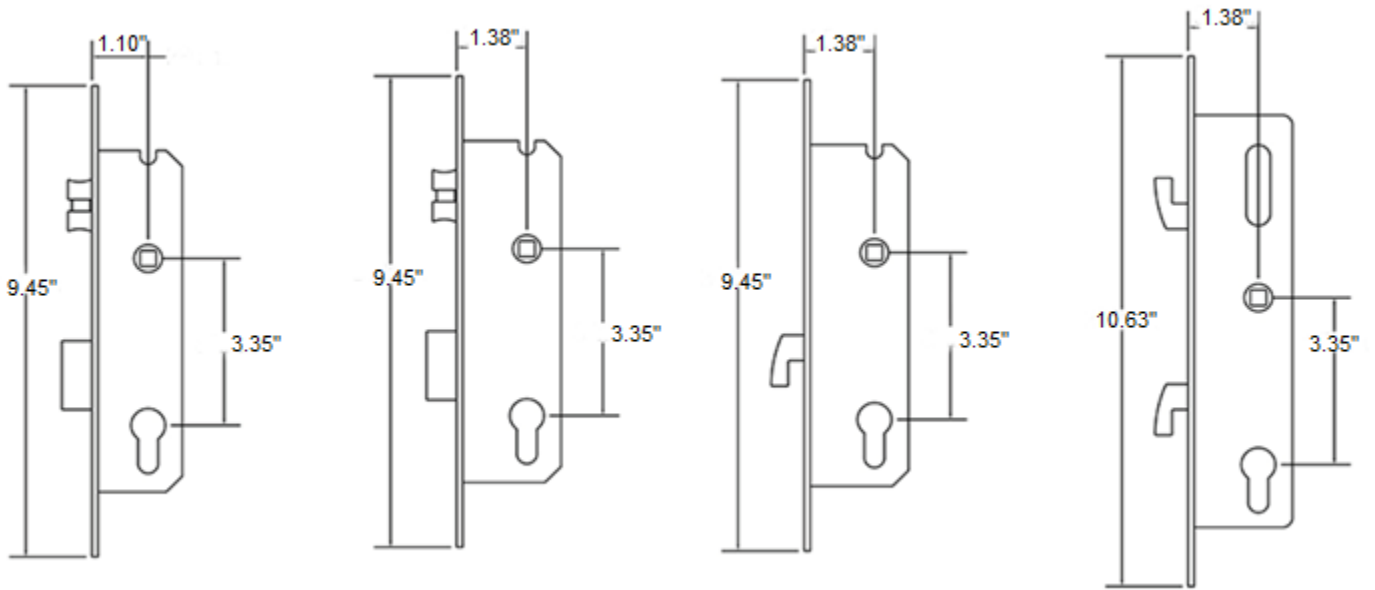

**ABLOY LE314**

# LOCK CASES FOR WOODEN AND SECURITY DOORS

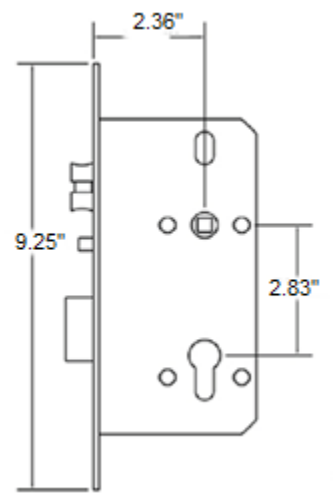
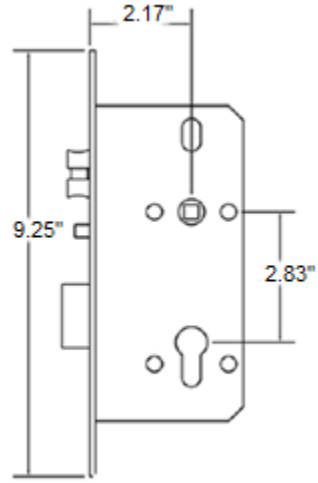
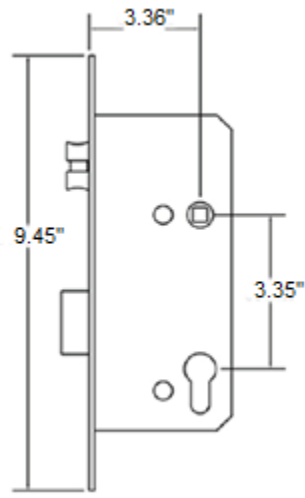
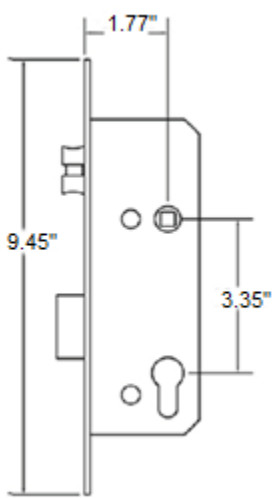

**ABLOY LE184**

**ASSA 510**

# INSTALLATION

## I. Install Mortise

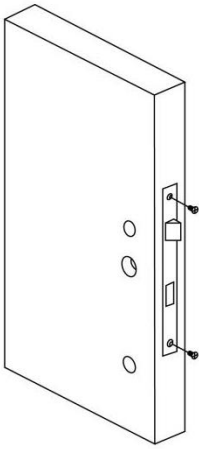

## II. Install Square Shaft and Hexagon Screw Casing

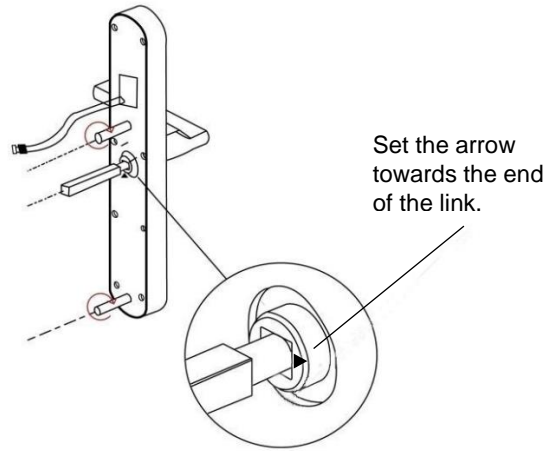

## III. Install Front Panel

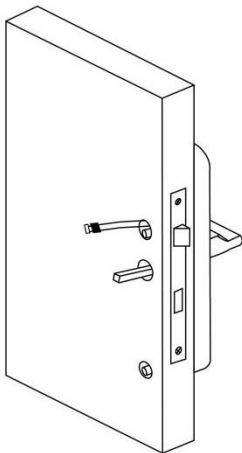

## IV. Install Back Panel

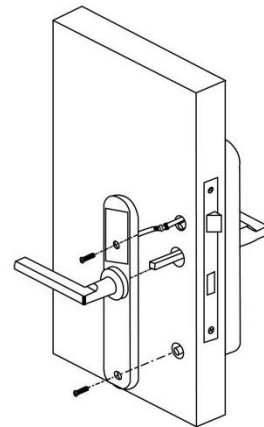

## V. Install the Battery

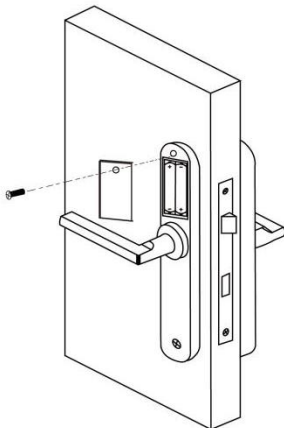

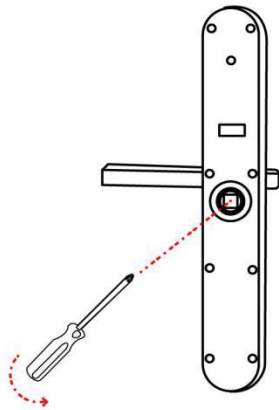

Turn the handle on the front panel.

Loosen the inner hexagon screw of the handle counterclockwise.

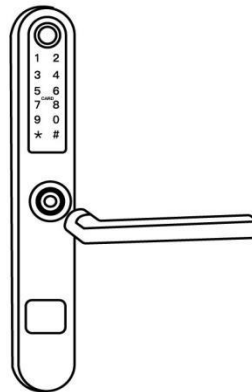

Remove the handle.

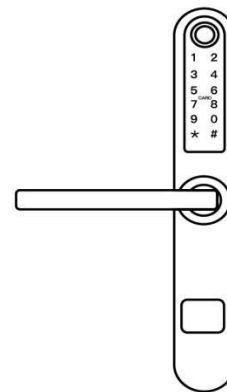

After adjusting the direction of the handle, insert it into the handle seat and re-lock the hexagon screw of the handle to complete the turning.

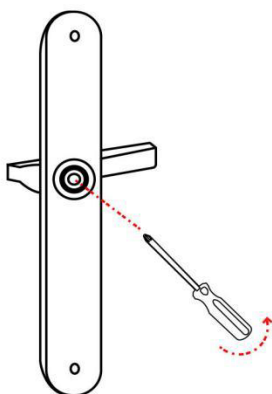

Turn the handle on back panel.

Loosen the inner hexagon screw of the handle counterclockwise.

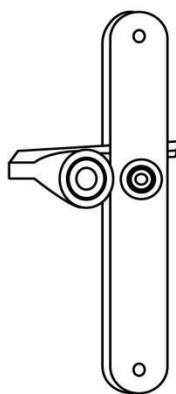

Remove the handle.

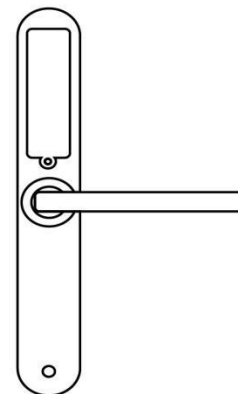

After adjusting the direction of the handle, insert it into the handle seat and re-lock the hexagon screw of the handle to complete the turning.

## SYSTEM INITIALIZATION

- I. Install the battery.
- II. Press the „Reset“ button on the back of the panel for 5 seconds.
- III. Press the number combination „000#“ and the initialization is complete



**Reset button**

## REGISTRATION



1. Open the camera of your smart phone. Scan the QR code according to your phone's operating system and download the free TTLock mobile app.
2. Register a new account using your phone number or email address.  
If the registration is successful, You will be redirected to the security question settings page.
3. Log in using your number or email account.



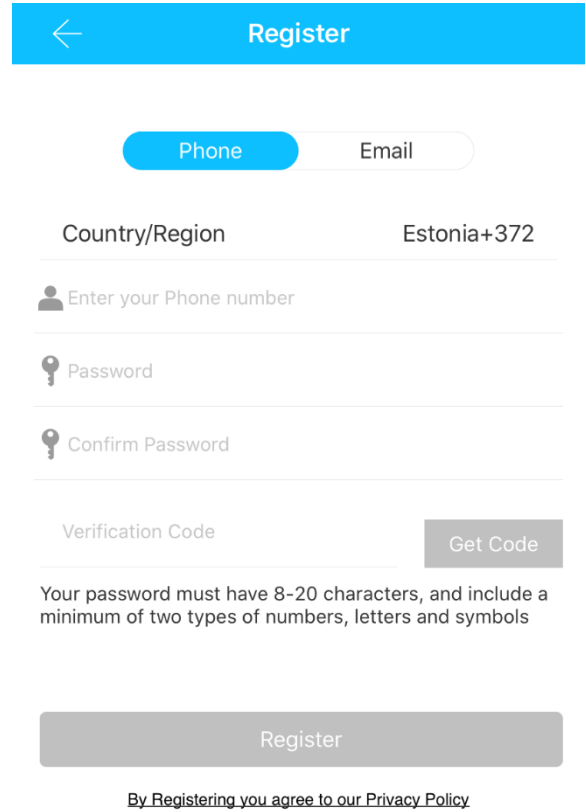
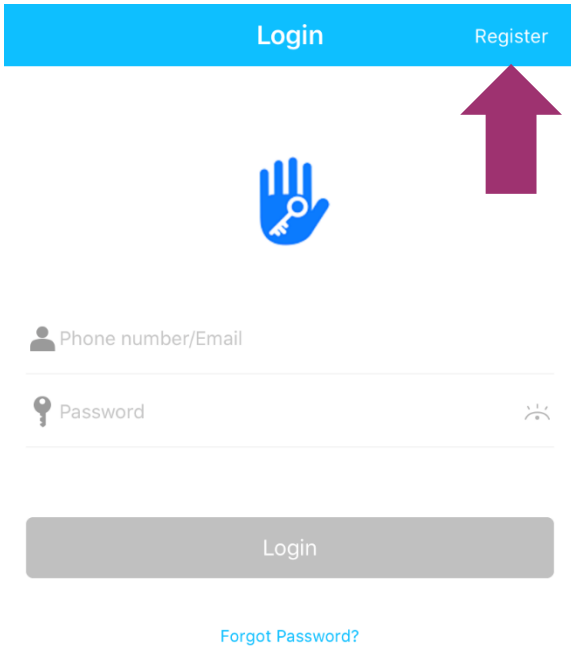

4. Touch the lock screen and press "Press to Add Lock". Select "Door Lock". The nearby lock is displayed on the screen, press "+".

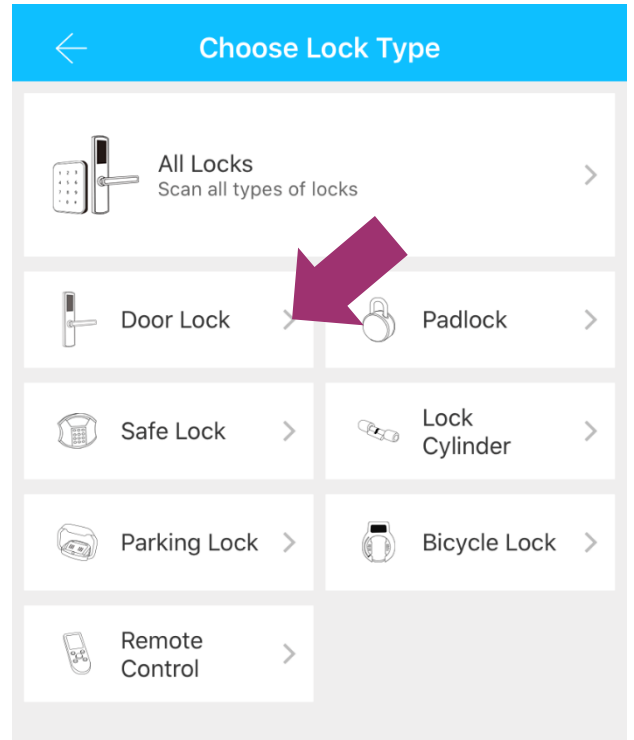
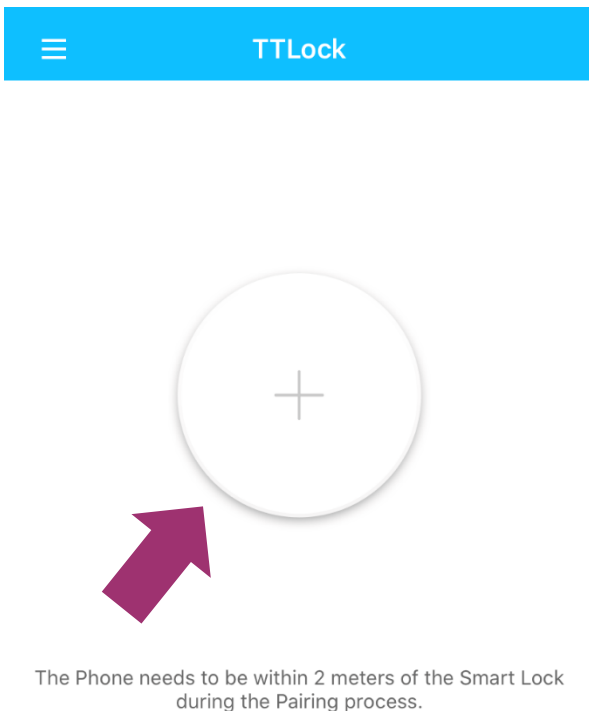

5. Rename the lock and press "OK". The lock is set.

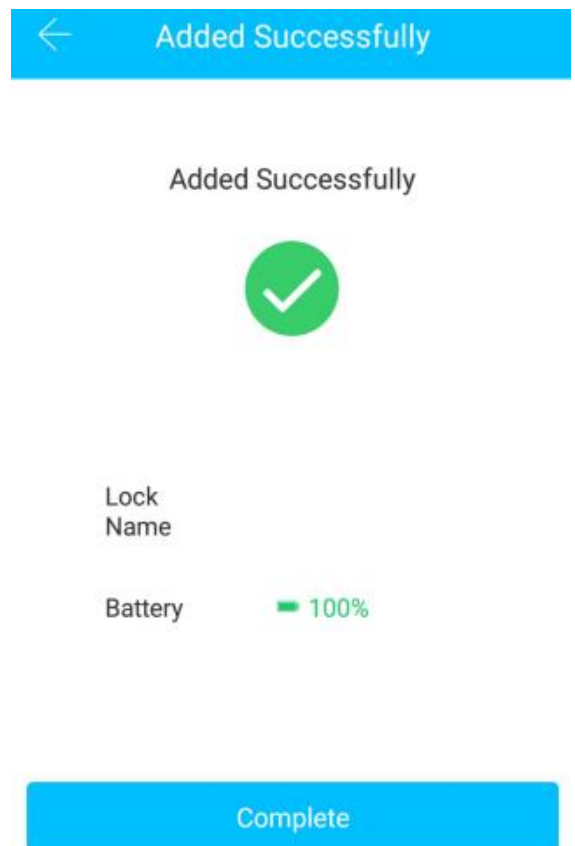
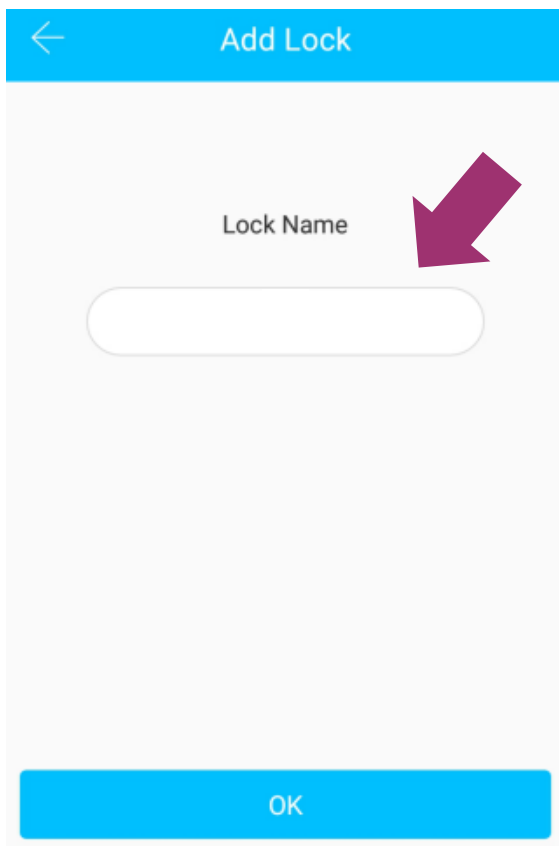

## UNLOCKING

The Halke smart lock has 6 different ways to unlock- fingerprint reader, PIN-code, WiFi opening, mobile APP, smart card and mechanical key. Unlocking operations can be done in the mobile APP TTLock and also on the website [www.ttlock.com](http://www.ttlock.com).

On the website [www.ttlock.com](http://www.ttlock.com), select from the menu „Software“ and from the drop-down menu „Lock Management“. Sign in with Your user account and perform all smart lock actions on the web.

### BLUETOOTH UNLOCK

Turn on Bluetooth in Your smart phone and open the TTLock mobile APP. Connect mobile and smart lock and press the button:  to open the lock. The distance between the mobile phone and the smart lock can not be longer than 5 meters. To lock, press on the same button for 3 seconds.

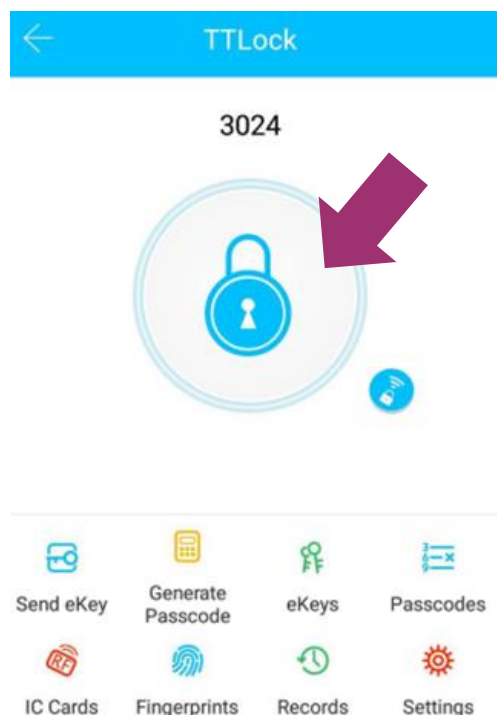

## REMOTE CONTROL UNLOCK

After confirming that Your phone and door lock are connected to the Gateway HUB G2V, click on the button:  You can unlock it anywhere if Your phone has a internet connection. The tutorial for connecting the Gateway with Your smartphone is in the next chapter.

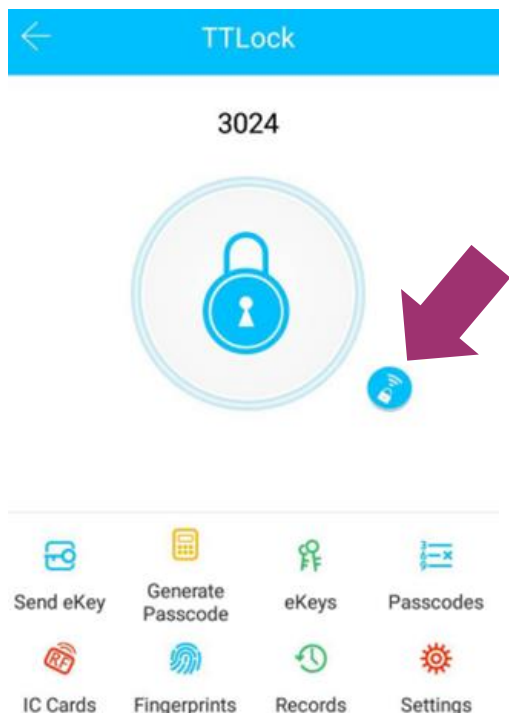

## BLUETOOTH KEY REMOTE AUTHORIZATION

Press the button  to send the remote authorization. The E-Key can be sent to the contacts on Your mobile phone and to the users of the TTLock APP using a username.

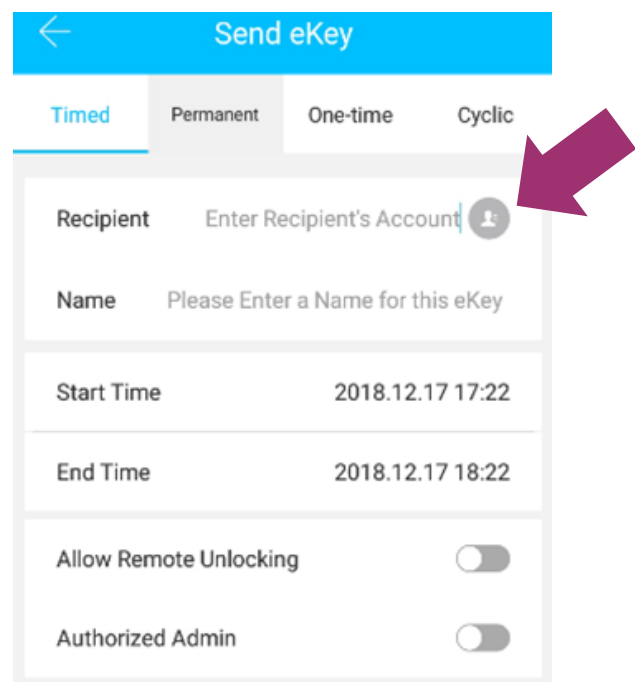

Give the E-Key a name and a duration. The duration can be limited (Timed), Permanent, One-time or Cyclic.

The screenshot shows the 'Send eKey' interface. At the top, there is a blue header with a back arrow and the text 'Send eKey'. Below the header, there are four tabs: 'Timed', 'Permanent', 'One-time', and 'Cyclic'. The 'Timed' tab is selected and highlighted with a red oval. Below the tabs, there are several input fields: 'Recipient' with the placeholder 'Enter Recipient's Account' and a person icon; 'Name' with the placeholder 'Please Enter a Name for this eKey'; 'Start Time' with the value '2018.12.17 17:22'; and 'End Time' with the value '2018.12.17 18:22'. Below these fields, there are two toggle switches: 'Allow Remote Unlocking' and 'Authorized Admin', both of which are currently turned off. A purple arrow points to these two toggle switches. At the bottom of the form, there is a grey button labeled 'Send'.

Specify whether the user of the E-Key can also unlock the lock over the Internet and if the user is an administrator of the lock. The e-key can be paused and deleted by the administrator user at any time.

## PASSWORD OPENING

You can create and manage your passwords at any time through your mobile or web. The password can be permanent, timed, one-time or recurring. The password can also be created with a custom number combination. You can create up to 150 different password combinations.

**The permanent password** works at any time without a time limit until it is deleted. It can be used, for example, for office workers or at home with family members. The password must be used in 24 hours after creating it, otherwise it will be deleted.

**The time-valid password** is suitable for hotels, Airbnb and hostels. The guest will have their own password which expires when the stay is over.

A time-limited password can have an expiration date of at least one hour and a maximum of three years. The time-limited password must be used within 24 hours, otherwise it will expire automatically.

How to change the time-valid password? Enter the original password to unlock, then enter "10 # original password # new password (between 4 and 6 digits) # re-enter new password #".

**The one-time password** is used only once and after using it, the password will be deleted and it is not possible to enter with the same password again from the door. A one-time password is valid for 6 hours.

**The cyclic password** can be used at certain times and repeatedly, for example to allow the cleaner, the dog walker, the babysitter, etc. to pass in time. By creating this password, you can select a specific day of the week and time for that day.

In the mobile APP, it is possible to **create a password with 4-6 numbers (Custom) with a number combination of your choice**. It is also possible to set a time validity for a password with a number combination. You can create up to 150 custom passwords.

The system shows the E-Key expiration warning in two colors. Yellow means that the key will expire soon, and red means that the E-Key has expired.

All created passwords can be viewed, managed, changed and deleted in the password management module.

## Password Management

Press the button  . See Admin Passcode. Click "Generate Passcode" and create an administrator password for the smart lock.

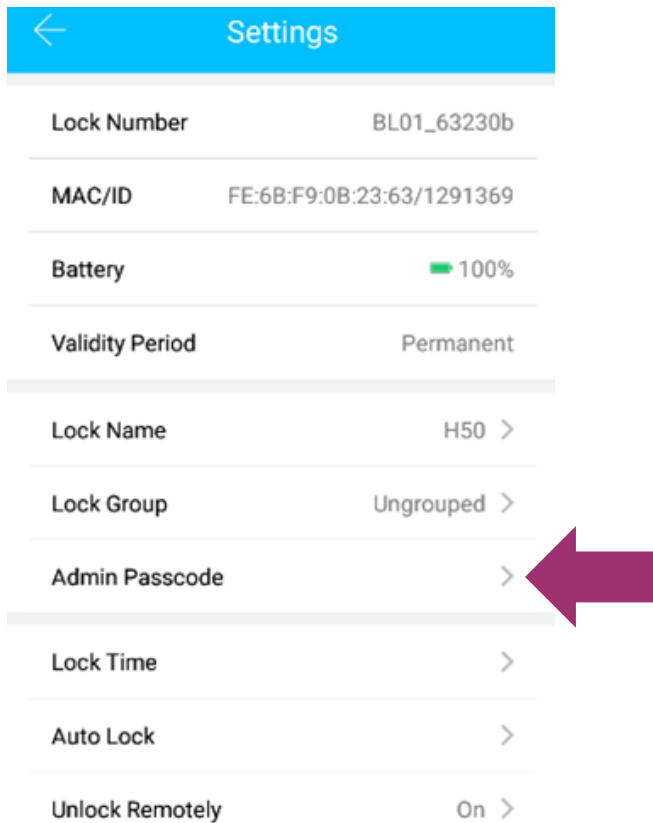

Press the button  . Select the appropriate password type (Permanent, Timed, One-Time, Custom), specify a name and expiration date for the password.

Click the "Generate" button and the mobile app will generate a 6-digit password. When creating a "Custom" password, a 4-digit number combination must be entered.

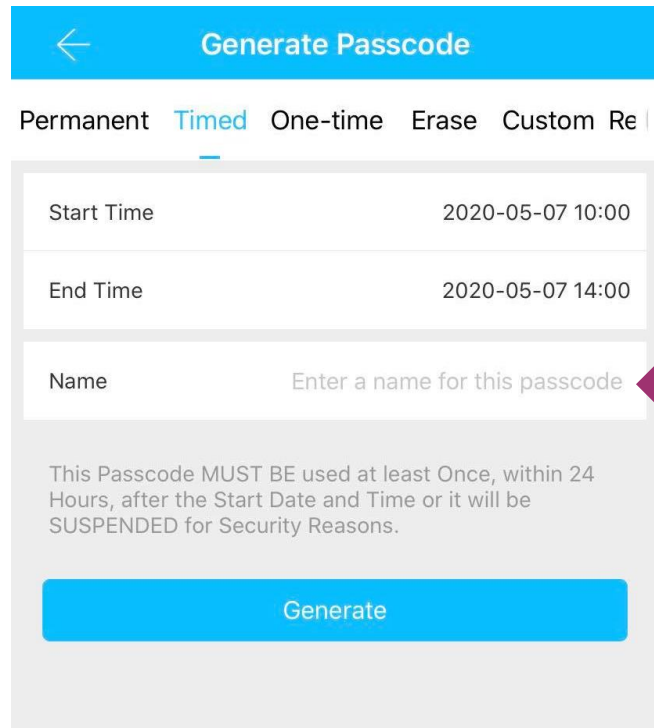
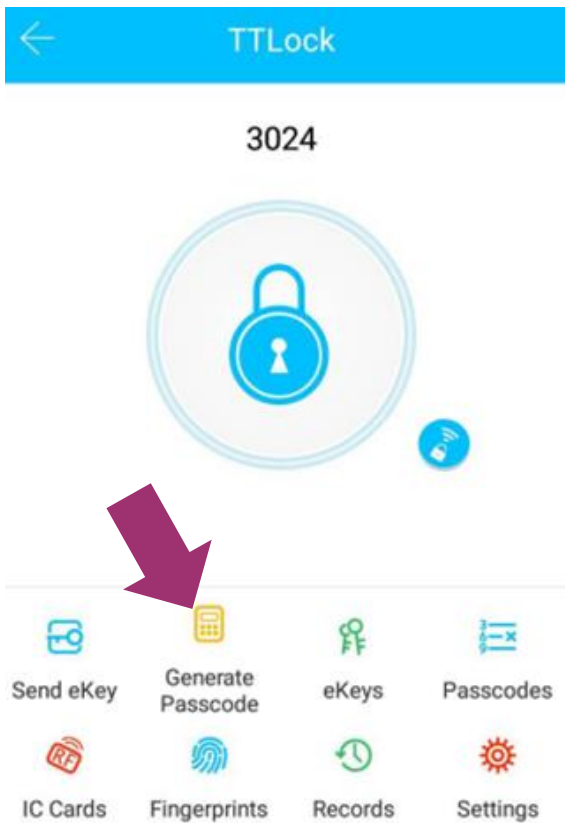

The password is ready for use. Enter the password and the "#" sign in the panel. Smart lock alerts and unlocks when you enter the correct password.

Smart lock allows you to create up to 150 different passwords. Expired passwords can be reactivated.

The passwords can be shared with users via SMS, e-mail, Facebook Messenger and the WhatsApp mobile app.

Press the button  , to see the unlock history.

## FINGERPRINT UNLOCKING

The fingerprint must be registered in the mobile APP before it can be used. It is possible to create a permanent or time-limited fingerprint unlock for the smart lock.

Press the button  and  and then „Add Fingerprint“.



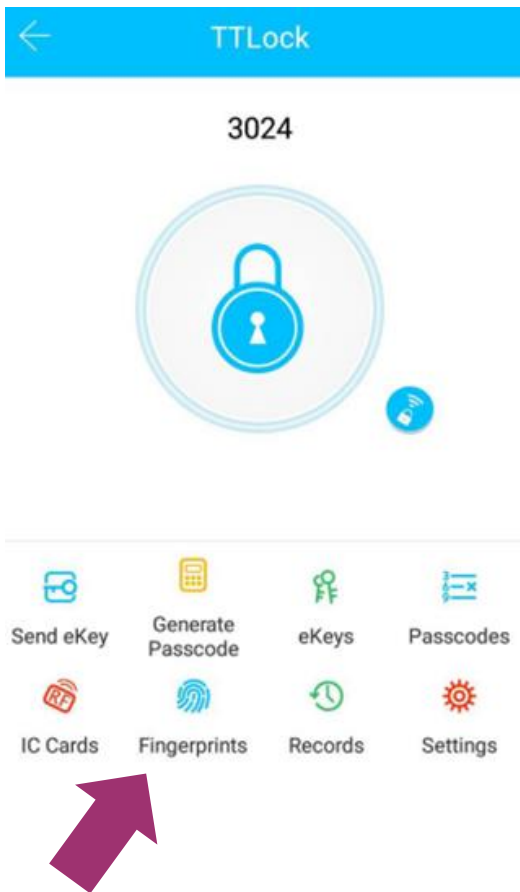



Give the fingerprint a name and a duration. Press "Start" and place your finger on the sensor. Follow the instructions in the mobile app. For one lock can be set up to 100 different fingerprints.

## CARD OPENING

The card must be set up before using it. The smart card can be permanent and it is also possible to set a time limit on the card. The lock allows to add up to 200 different cards.

Press the button  , then  and insert the smart card according to the instructions displayed in the mobile APP. The whole process must be done through the APP next to the lock. The validity period of the IC card can be set to either permanent or time-limited.

All IC cards can be managed via the IC card management module. For Gateway, the remote card issuance function is displayed. If there is no Gateway, this function is hidden.



# GATEWAY

## Set up the connection between the gateway and the phone

- A. Connect Your phone to the Wi-Fi network to which the gateway is connected.
- B. Click the plus button in the upper right corner and enter the WiFi password and Gateway name. Click OK and enter the password for authentication.
- C. Press and hold the gateway setup button for 5 seconds. A green light indicates that the gateway has entered insertion mode.



When the Gateway is powered on:

-  Light flashes alternately in red and blue: stand-by mode, ready to pair
-  Blue light: working mode
-  Red light: network failure

## Pair the Gateway with APP

1 Activate the APP



2 Press "☰"



3 Select „Gateway“



7 Add Gateway



8 Select the network and fill in the password

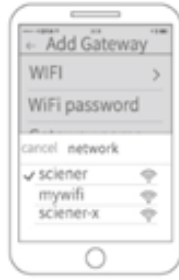

9 Add complete

4 Select „G2“



5 Plug in the Gateway and power it on while the light flashes in red and blue

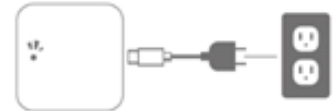











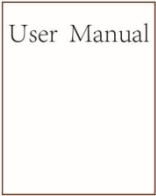

6 Press „+“ sign



If the connection fails, unplug the Gateway and repeat the process.

# PACKAGE

				
Name	Front Panel	Rear Panel	Manual	Mortise
Quantity	1	1	1	1
				
Name	Striker	Pointed screw	Mechanical Key	Card
Quantity	1	4	2	3
				
Name	Square screw	Spring	Fixing screws	Hexagon screw
Quantity	1	1	2	2
				
Name	<b>HUB G2V</b> Not included			

## QUESTIONS

### SMART LOCK

#### How can I set the time on the smart lock?

The application automatically adjusts the internal clock of the smart lock when used with a 3G / 4G / WiFi connected phone.

#### Is it possible to mute voice instructions on a smart lock?

Yes, you need to select "Settings" → "Lock Sound" → "Turn off". You can reactivate voice guidance at any time.

### NUMBER PANEL

#### Why does the light on the keyboard goes out as soon as I activate the smart lock?

This feature is for security purposes. If you enter the wrong PIN five times in a row, the lock is inactive for 5 minutes. To activate the lock immediately, you need to unlock it from the mobile app.

#### Why does the light on the number panel flash?

When you enter the password on the number panel, the light flashes to indicate that the battery is low. Replace the smart lock batteries immediately.

#### Why doesn't the number panel work?

The batteries may be empty, replace the batteries.

### PASSWORD

#### How long is the PIN valid?

The permanent password is set indefinitely and does not expire. A scheduled password can be set for a maximum of three years.

#### What happens if the user and smart lock are in different time zones?

The time is set according to the time zone of the smart phone user's phone.

## **Why can't I set a password start and end time?**

Some previous generation smart locks do not have the ability to set the time. These smart locks can only set a password period.

## **Why is my password not working?**

- The password has been deleted.
- The password was never used within 24 hours of activation.
- The password time is expired.
- The smart lock time is incorrect.

## **MOBILE APP TTLOCK**

### **Why can't I control my smart lock through the mobile APP?**

There are several ways to do this:

- Your e-Key has been deleted, suspended or expired.
- The mobile phone does not work or Bluetooth is turned off. To resolve this, close the application, turn on Bluetooth on your phone, and reopen the mobile application.

## **OTHER**

### **How can I deactivate an eKey, fingerprint, PIN code or smart card?**

All factors mentioned in the question can be deleted in the TTLock APP

### **What is a Gateway?**

The HUB G2V control center is connected to your WiFi network and works with your smartphone over the Internet.

### **Can I manage the smart lock on the web?**

Yes. You need to go to [www.ttlock.com](http://www.ttlock.com), select „Software“ from the menu and „Lock Management“ from the drop-down menu. Log in with your TTLock account and pressing the lock opens a view of the different actions that can be performed with the lock.



**LOCK FORCE OÜ**

Laki 30, Tallinn 12915

Ph: +372 660 9997, e-mail: [info@lockforce.ee](mailto:info@lockforce.ee)

[www.lockforce.ee](http://www.lockforce.ee)